

IRF7901D1PbF

- Co-Pack Dual N-channel HEXFET® Power MOSFET and Schottky Diode
- Ideal for Synchronous Buck DC-DC Converters Up to 5A Peak Output
- Low Conduction Losses
- Low Switching Losses
- Low Vf Schottky Rectifier
- Lead-Free

Dual FETKY™ Co-Packaged Dual MOSFET Plus Schottky Diode

Device Ratings (Max. Values)

	Q1	Q2 and Schottky
V_{DS}	30V	30V
$R_{DS(on)}$	38 mΩ	32 mΩ
Q_G	10.5 nC	18.3 nC
Q_{sw}	3.8 nC	9.0 nC
V_{SD}	1.0V	0.52V

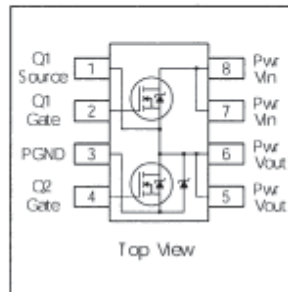

Description

The FETKY™ family of Co-Pack HEXFET® MOSFETs and Schottky diodes offers the designer an innovative, board space saving solution for switching regulator and power management applications. Advanced HEXFET® MOSFETs combined with low forward drop Schottky results in an extremely efficient device suitable for a wide variety of portable electronics applications.

The SO-8 has been modified through a customized leadframe for enhanced thermal characteristics and multiple die capability making it ideal in a variety of power applications. With these improvements, multiple devices can be used in an application with dramatically reduced board space. Internal connections enable easier board layout design with reduced stray inductance.

Absolute Maximum Ratings

Parameter	Symbol	IRF7901D1	Units
Drain-Source Voltage	V_{DS}	30	V
Gate-Source Voltage	V_{GS}	±20	
Continuous Output Current ($V_{GS} \geq 4.5V$)④	I_D	6.2	A
Pulsed Drain Current①			
Power Dissipation③	P_D	2.0	W
Junction & Storage Temperature Range			
Pulsed Source Current ①	I_{SM}	12	A

Thermal Resistance

Parameter		Max.	Units
Maximum Junction-to-Ambient③	$R_{\theta JA}$	62.5	°C/W
Maximum Junction-to-Lead⑤	$R_{\theta JL}$	25	°C/W

IRF7901D1PbF

International
IR Rectifier

Electrical Characteristics		Q1 - Control FET			Q2 - Synch FET & Schottky			Units	Conditions
Parameter		Min	Typ	Max	Min	Typ	Max		
Drain-to-Source Breakdown Voltage*	BV_{DSS}	30	-	-	30	-	-	V	$V_{GS} = 0V, I_D = 250\mu A$
Static Drain-Source on Resistance*	$R_{DS(on)}$	-	28	38	-	23	32	m Ω	$V_{GS} = 4.5V, I_D = 5A$ Ⓢ
Gate Threshold Voltage*	$V_{GS(th)}$	1.0	-	-	1.0	-	-	V	$V_{DS} = V_{GS}, I_D = 250\mu A$
Drain-Source Leakage	I_{DSS}	-	-	30	-	-	30	μA	$V_{DS} = 24V, V_{GS} = 0$
		-	-	0.15	-	-	4.3	mA	$V_{DS} = 24V, V_{GS} = 0, T_J = 125^\circ C$
Gate-Source Leakage Current*	I_{GSS}	-	-	± 100	-	-	± 100	nA	$V_{GS} = \pm 20V$
Total Gate Charge*	$Q_{G cont}$	-	7.6	10.5	-	15.5	21.0	nC	$V_{GS} = 5V, V_{DS} = 16V, I_D = 5A$
	$Q_{G synch}$	-	6.7	9.0	-	13.5	18.3		$V_{GS} = 5V, V_{DS} = 100mV, I_D = 5A$
Pre-Vth Gate-Source Charge	Q_{GS1}	-	2.0	-	-	5.5	-		$V_{DS} = 16V, I_D = 5A$
Post-Vth Gate-Source Charge	Q_{GS2}	-	0.5	-	-	0.9	-		
Gate to Drain Charge	Q_{GD}	-	1.9	-	-	4.7	-		
Switch Charge* ($Q_{GS2} + Q_{GD}$)	Q_{sw}	-	2.4	3.8	-	5.6	9.0		
Output Charge*	Q_{oss}	-	13.5	18.0	-	9.0	12.3		$V_{DS} = 16V, V_{GS} = 0$
Gate Resistance	R_G	-	3.4	-	-	4.3	-		Ω
Input Capacitance	C_{iss}	-	780	-	-	1810	-		pF
Output Capacitance	C_{oss}	-	430	-	-	310	-		
Transfer Capacitance	C_{rss}	-	30	-	-	110	-		
Turn-On Delay Time	$t_{d(on)}$	-	7.2	-	-	10.4	-	ns	$V_{DD} = 16V, I_D = 5A, V_{GS} = 5V$ Clamped inductive load See test diagram Fig 17.
Rise Time	t_r	-	13.8	-	-	16.4	-		
Turn-Off Delay Time	$t_{d(off)}$	-	14.7	-	-	14.6	-		
Fall Time	t_f	-	8	-	-	5.2	-		

Source-Drain Ratings and Characteristics

Parameter		Q1			Q2 & parallel Schottky			Units	Conditions
		Min	Typ	Max	Min	Typ	Max		
Diode Forward Voltage*Ⓢ	V_{SD}	-	0.7	1.0	-	0.48	0.52	V	$I_S = 1A, V_{GS} = 0V$
Reverse Recovery Charge	Q_{rr}	-	62.3	-	-	8.9	-	nC	$di/dt = 700A/\mu s$ $V_{DS} = 16V, V_{GS} = 0V, I_S = 5A$

- ① Repetitive rating; pulse width limited by max. junction temperature.
 ② Pulse width $\leq 300 \mu s$; duty cycle $\leq 2\%$.
 ③ When mounted on 1 inch square copper board, $t < 10$ sec.

- Ⓢ Combined Q1, Q2 I_{RMS} @ Pwr V_{GS} pins. Calculated continuous current based on maximum allowable junction temperature; switching or other losses will decrease RMS current capability
 Ⓣ When mounted on IRNBPS2 design kit. Measured as device T_J to Pwr leads (V_{in} & V_{out})
 * Devices are 100% tested to these parameters.

Power MOSFET Optimization for DC-DC Converters

Table 1 and Table 2 describes the event during the various charge segments and shows an approximation of losses during that period.

Table 1 – Control FET Losses

	Description	Segment Losses
Conduction Loss	Losses associated with MOSFET on time. I_{RMS} is a function of load current and duty cycle.	$P_{COND} = I_{RMS}^2 \times R_{DS(on)}$
Gate Drive Loss	Losses associated with charging and discharging the gate of the MOSFET every cycle. Use the control FET Q_G .	$P_{IN} = V_G \times Q_G \times f$
Switching Loss	Losses during the drain voltage and drain current transitions for every full cycle. Losses occur during the Q_{GS2} and Q_{GD} time period and can be simplified by using Q_{switch} .	$P_{OGS2} = V_{IN} \times I_L \times \frac{Q_{GS2}}{I_G} \times f$ $P_{OGD} = V_{IN} \times I_L \times \frac{Q_{GD}}{I_G} \times f$ $P_{SWITCH} = V_{IN} \times I_L \times \frac{Q_{SW}}{I_G} \times f$
Output Loss	Losses associated with the Q_{OSS} of the device every cycle when the control FET turns on. Losses are caused by both FETs, but are dissipated by the control FET.	$P_{OUTPUT} = \frac{Q_{OSS}}{2} \times V_{IN} \times f$

Table 2 – Synchronous FET Losses

	Description	Segment Losses
Conduction Loss	Losses associated with MOSFET on time. I_{RMS} is a function of load current and duty cycle.	$P_{COND} = I_{RMS}^2 \times R_{DS(on)}$
Gate Drive Loss	Losses associated with charging and discharging the gate of the MOSFET every cycle. Use the Sync FET Q_G .	$P_{IN} = V_G \times Q_G \times f$
Switching Loss	Generally small enough to ignore except at light loads when the current reverses in the output inductor. Under these conditions various light load power saving techniques are employed by the control IC to maintain switching losses to a negligible level.	$P_{SWITCH} = 0$
Output Loss	Losses associated with the Q_{OSS} of the device every cycle when the control FET turns on. They are caused by the synchronous FET, but are dissipated in the control FET.	$P_{OUTPUT} = \frac{Q_{OSS}}{2} \times V_{IN} \times f$

Typical Application

The performance of the new Dual FETKY™ has been tested in-circuit using IR's new IRNBPS2 "Dual Output Synchronous Buck Design Kit", operating up to 21V_{in} and 5A peak output current, with operating voltages from 1V_{out} to 5V_{out}.

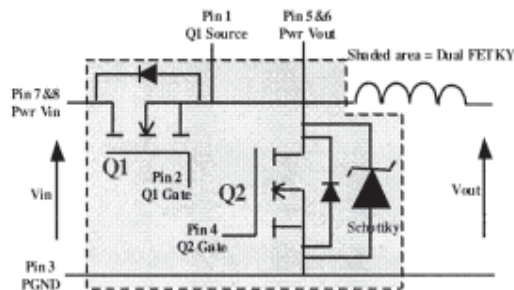

Figure 1: Synchronous Buck dc-dc Topology

IRF7901D1PbF

International
IR Rectifier

Typical Application (Contd.)

The Dual FETKY integrates all the power semiconductor devices for DC-DC conversion within one SO-8 package, as shown on page 1. The high side control MOSFET (Q1) is optimized for low combined Q_{sw} and $R_{DS(on)}$. The low side synchronous MOSFET (Q2) is optimized for low $R_{DS(on)}$ and high Cdv/dt immunity. The ultra-low V_f schottky diode is internally connected in parallel with the synchronous MOSFET, for improved deadtime efficiency. For ease of circuit board layout, the Dual FETKY has been internally configured such that it represents a functional block for the power device portion of the synchronous buck DC-DC converter. This helps to minimize the external PCB traces compared to a discrete solution.

In-Circuit Efficiency

The in-circuit efficiency curves for the Dual FETKY are shown in Figure 2 & 3. The Dual FETKY can achieve up to 96.6% and 94.6% peak efficiency for the 5.0V and 3.3V applications respectively, with excellent maximum load efficiency.

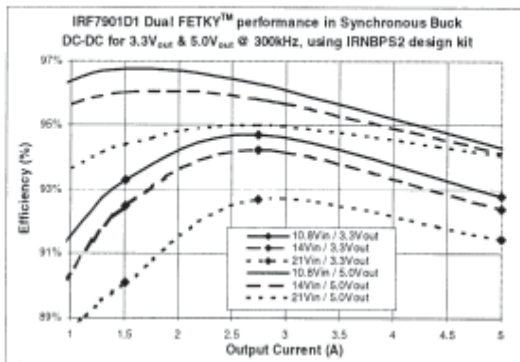

Figure 2. IRF7901D1 Dual FETKY™ electrical efficiency at 3.3Vout & 5.0Vout.

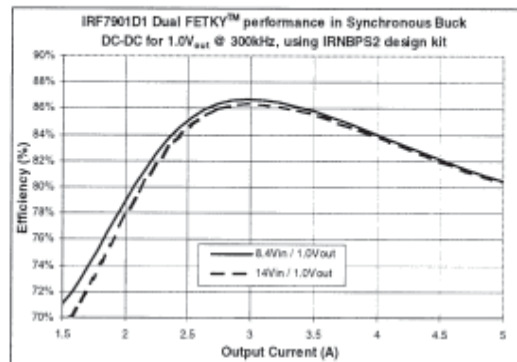

Figure 3. IRF7901D1 Dual FETKY™ electrical efficiency at 1.0Vout.

Typical Characteristics

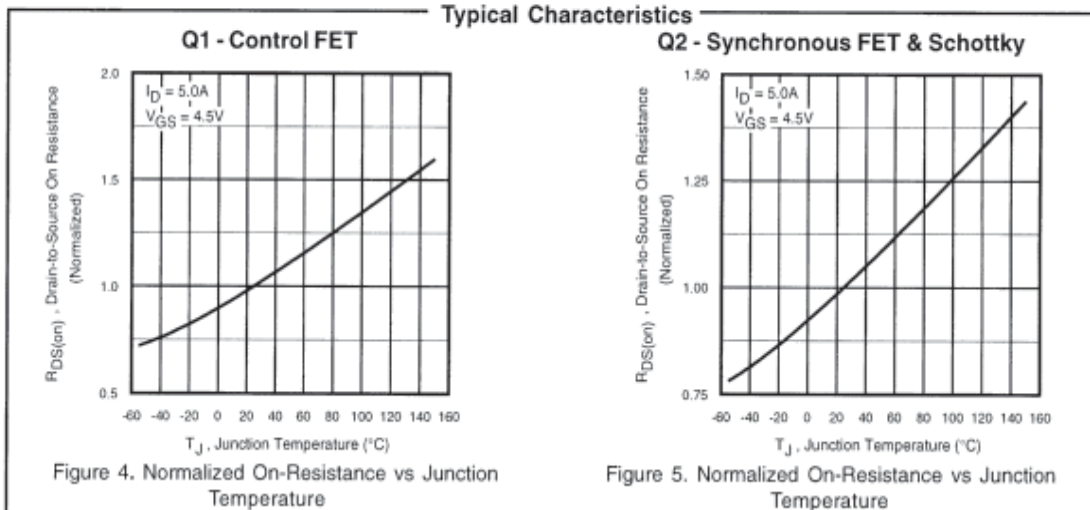

Figure 4. Normalized On-Resistance vs Junction Temperature

Figure 5. Normalized On-Resistance vs Junction Temperature

Typical Characteristics

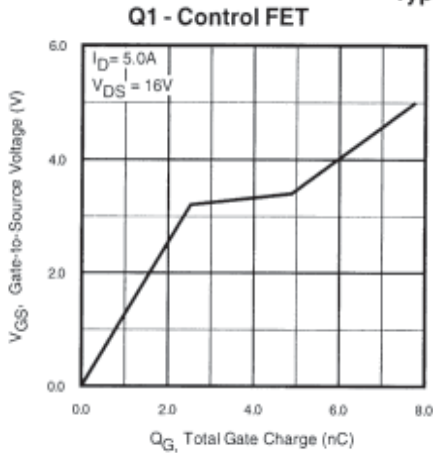

Figure 6. Gate-to-Source Voltage vs Typical Gate Charge

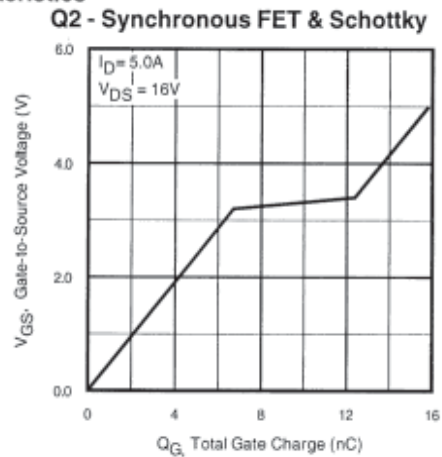

Figure 7. Gate-to-Source Voltage vs Typical Gate Charge

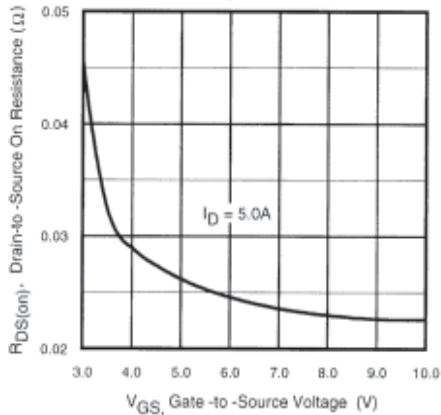

Figure 8. Typical $R_{DS(on)}$ vs Gate-to-Source Voltage

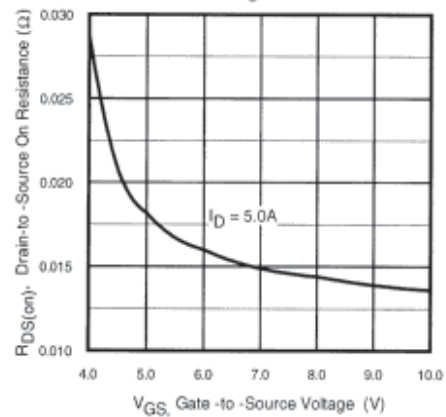

Figure 9. Typical $R_{DS(on)}$ vs Gate-to-Source Voltage

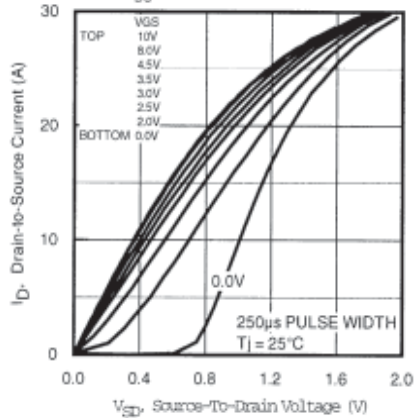

Figure 10. Typical Reverse Output Characteristics

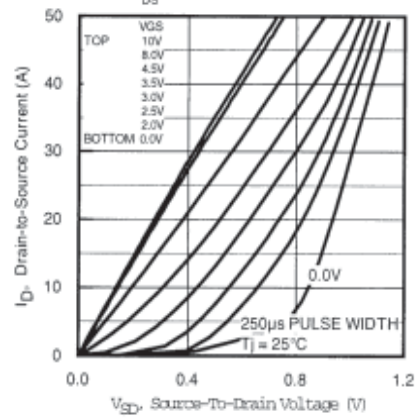

Figure 11. Typical Reverse Output Characteristics

Typical Characteristics

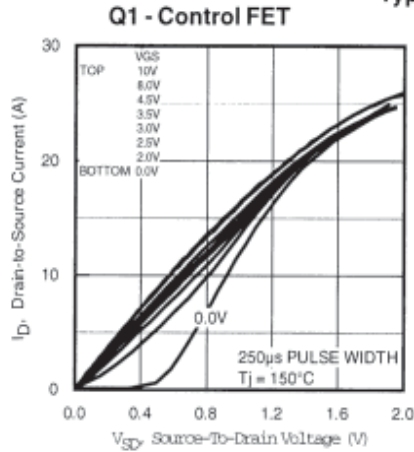

Figure 12. Typical Reverse Output Characteristics

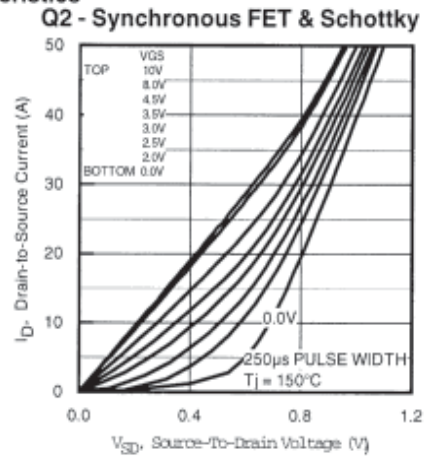

Figure 13. Typical Reverse Output Characteristics

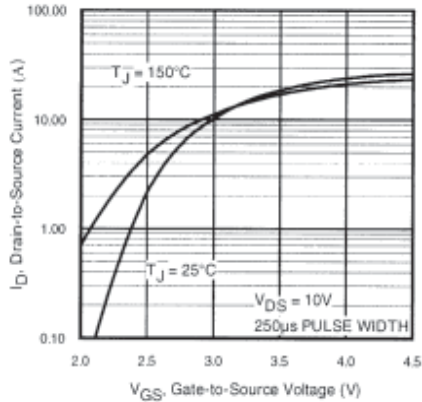

Figure 14. Typical Transfer Characteristic

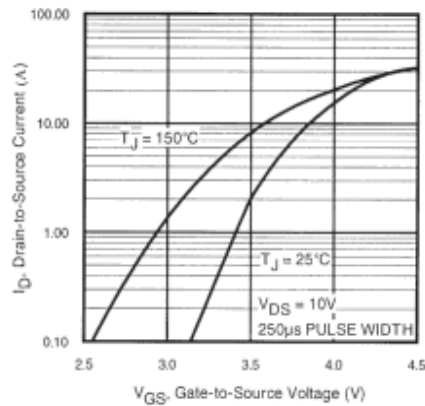

Figure 15. Typical Transfer Characteristic

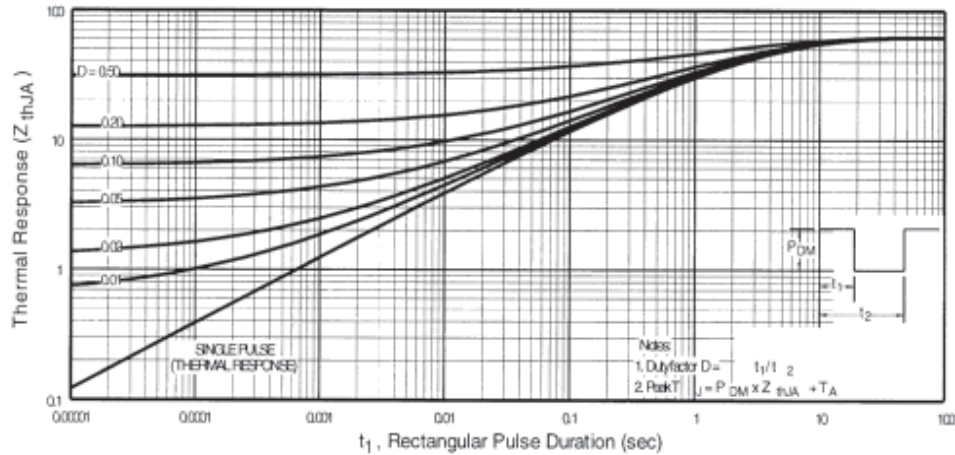

Figure 16. Maximum Effective Transient Thermal Impedance, Junction-to-Ambient

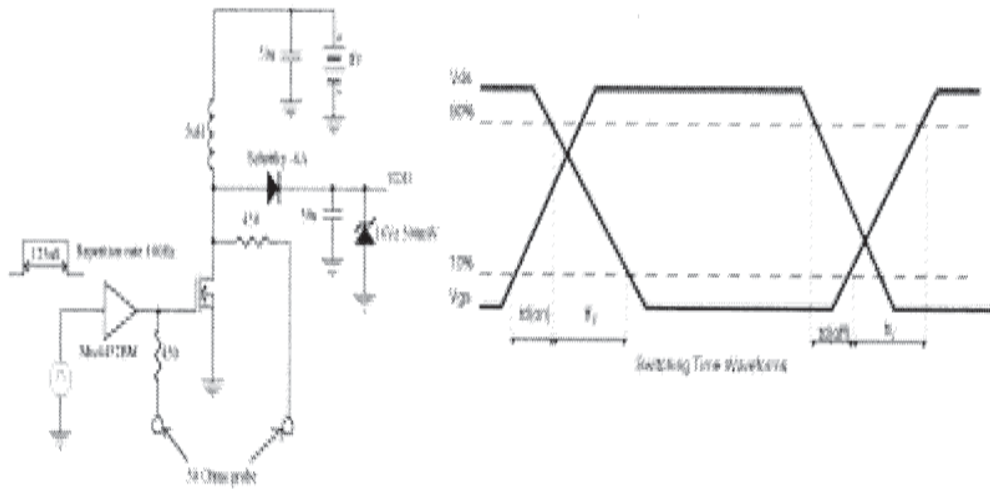

Figure 17. Clamped Inductive Load Test Diagram and Switching waveform.

IRF7901D1PbF

International
IR Rectifier

SO-8 (Fetky) Package Outline

Dimensions are shown in millimeters (inches)

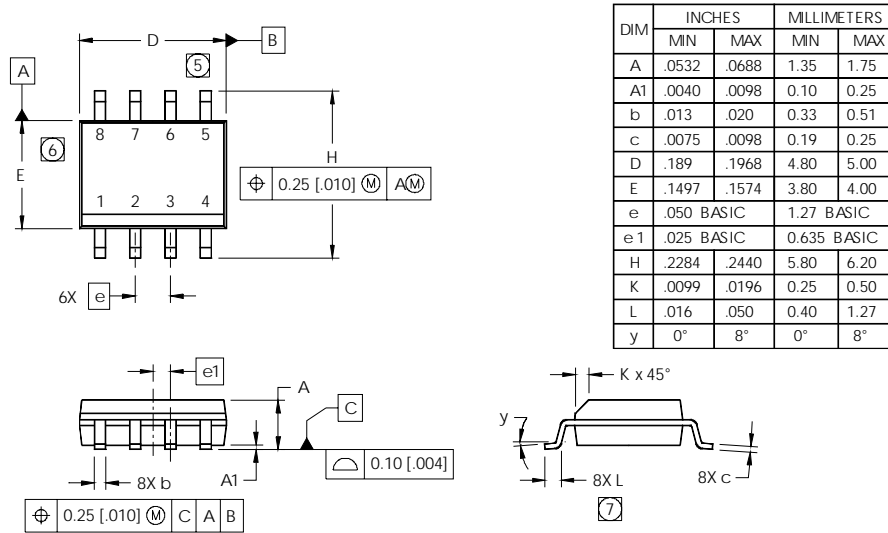

NOTES:

1. DIMENSIONING & TOLERANCING PER ASME Y14.5M-1994.
2. CONTROLLING DIMENSION: MILLIMETER
3. DIMENSIONS ARE SHOWN IN MILLIMETERS [INCHES].
4. OUTLINE CONFORMS TO JEDEC OUTLINE MS-012AA
- 5 DIMENSION DOES NOT INCLUDE MOLD PROTRUSIONS. MOLD PROTRUSIONS NOT TO EXCEED 0.15 [0.06].
- 6 DIMENSION DOES NOT INCLUDE MOLD PROTRUSIONS. MOLD PROTRUSIONS NOT TO EXCEED 0.25 [0.10].
- 7 DIMENSION IS THE LENGTH OF LEAD FOR SOLDERING TO A SUBSTRATE.

FOOTPRINT

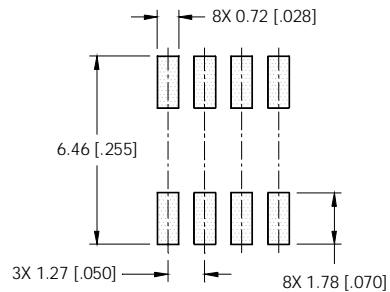

SO-8 (Fetky) Part Marking Information

EXAMPLE: THIS IS AN IRF7807D1 (FETKY)

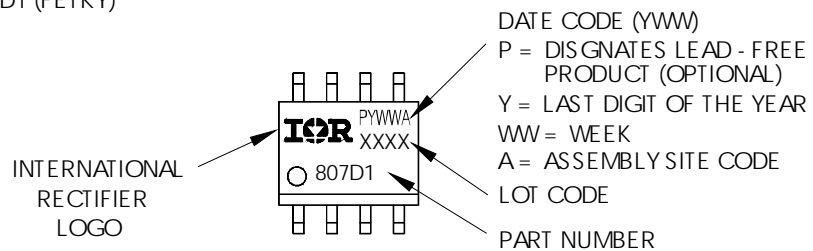

SO-8 (Fetky) Tape and Reel

Dimensions are shown in millimeters (inches)

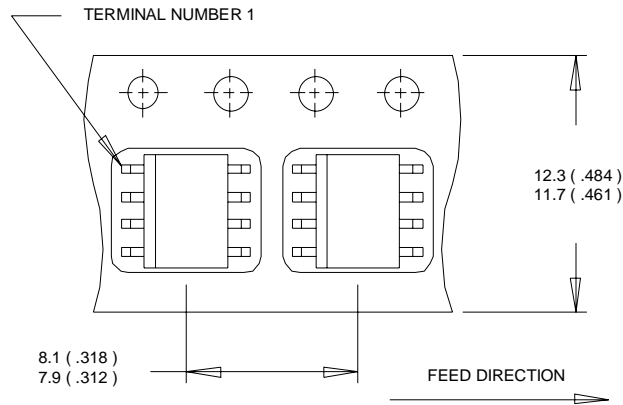

NOTES:

1. CONTROLLING DIMENSION : MILLIMETER.
2. ALL DIMENSIONS ARE SHOWN IN MILLIMETERS(INCHES).
3. OUTLINE CONFORMS TO EIA-481 & EIA-541.

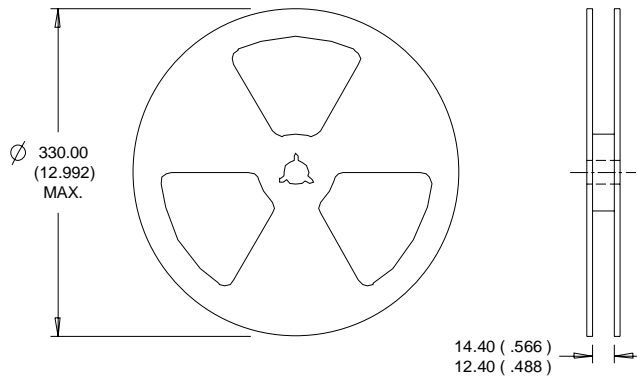

NOTES:

1. CONTROLLING DIMENSION : MILLIMETER.
2. OUTLINE CONFORMS TO EIA-481 & EIA-541.

Data and specifications subject to change without notice.
 This product has been designed and qualified for the Consumer market.
 Qualifications Standards can be found on IR's Web site.